



ATECO CORPORATION

اتيكو كورپوريشن

www.ateco.co



YOUR SMART LIFT SOLUTION

Add value to your property,
lift your lifestyle with
ATECO OCTAGON



38 El-Thawra St, Almazah, Heliopolis - Cairo
Building 696 El-Horreya Road - Loran - Alexandria.



+201020039264 - +201020039266 - +202 22903783



info@ateco.co



ABOUT HOME LIFT

Who we are

HOMEATECOLIFT is an agile & dynamic firm located in EGYPT, As experts in our business , we provide the highest standard of products & safety to the elevator industry. As a family owned and operated company, we aim to treat you like family as well. Our team wants you to feel comfortable throughout the production-process, ensuring we're creating the 'look & feel' you want in an efficient and safe manner.

Compliance & Safety

You can sleep well at night knowing that safety and compliance are at the heart of everything we do, from start to finish. We want your elevator to look incredible, but we will not sacrifice safety for design. We always work with high-quality materials and highly-qualified employees to create stunning elevator designs that pass inspections with flying colors.

Why ATECO OCTAGON LIFT

It is not a luxury option but rather a **smart choice!**

Home lifts are becoming so popular. Many architects are now drawing them into their plans for all multiple-story homes. Life is changing, and our lifestyle is evolving every day. The population is growing recently, people have to build up because they can't afford the land to build out. Still, many people think that having a home lift is a luxury option. We hear this cliché: this is only for 'rich people. Well, at **HOME elevators** we believe that the concept of home-lift must be affordable for every-body, all kinds of properties, any time and everywhere on this planet simply because that is possible!

Our home-lift design will allow you for example to create a new access from your garages to the upstairs, to lift your furniture or heavy objects smoothly between floors, to move safely with your little newborn child in your house, to make the life of our disabled family members easier and happier, to make your clients have a new and unique lift-experience while shopping in your store or staying at your hotel, and so on. Think about it, a home lift does not differ from any other heavy equipment in your house such as air-conditioning or even the washing machine. It is there to make our life **smarter** and more **comfortable**. Also keep in mind that home-elevators can add a new value to your property and increase its position in the market.

So keep in mind, It is not a luxury option but rather a **smart choice** and **long-term thinking!**



What Makes us Unique?



Smart Civil Work

This lift is an ideal solution to be installed on the exterior face of the building, in the lobby, or at a place where it can enhance the elevation and the 'look&feel' of the building. We introduce you to an electrical home elevator that requires no supporting wall, pit, or hydraulics vacuum systems. Just plug it into your domestic electrical socket and start moving up & down!



Minimal Maintenance

This is an electrical self-supporting elevator. No use of oil, vacuum systems, or counterweights. This means less maintenance and saves a lot of additional costs and time during the installation-process.



Plug & Play

These Elevators come as a semi-assembled unit. just install, plug and play. No surprises!



Self-Supported Structure

HOME ATECO OCTAGON is a stand-alone elevator that does not require any supporting beam, column or walls. All you need is the space!



Panoramic View

The unique glass sightseeing capsule enables the passengers to have eye contact with the surrounding area, even when the lift is in motion.



Green Elevator

This elevator is made of eco-friendly raw materials that are harmless when damaged. It requires the least amount of assembly and maintenance resources and consumes less energy when in use compared to the other traditional elevators.



Noise

When using **HOME ATECO OCTAGON**, you can count on a smooth moving system with no commotion.





Why can you place full trust in HOME Lift technology?

As pioneers and experts in this field, we are aware of any potential risks that might accrue when using residential home lifts. This is why we have gone the whole way to obtain a full European certification for our product making sure that safety is in the heart of every piece of this elevator. By choosing **ATECO OCTAGON** you choose to bring a highly proven type of lift machine into your property.

HOME **ATECO OCTAGON LIFT** have been tested thoroughly and has met the required safety & performance standards of the **Machine Directive 2006/42/EC**. This directive harmonizes the health and safety requirements for the design and construction of machinery at the EU level to the primary protection of persons.

8 LAYERS OF SAFETY

Photosell Sensors

This high quality light sensor will force the lift to stop immediately when passengers or objects approach the exit of the lift while in use.

1

Mechanical Guide Rails Brakes

Even if all the cables snapped, the elevator still would not fall to the bottom floor. Thanks to the passive, automatic, built-in braking system these brakes will lock in place whenever the elevator starts to fall faster than an allowed amount.

2

Overload Sensor

When the car is overloaded, the elevator won't move and will give a sign on the COP.

3

Limit & Emergency Stop Switches

These switches will assure stopping the car when the lift reaches or passes its final destination or in case of emergency.

4

Machine Brake Hand

In case of emergency this system allows the technician to free the car and make it descent to the closest down floor.

5

Magnetic Lock Switch

To ensure that the door of the elevator can open only if the car is available and the elevator is not in use.

6

Overspeed Governor

This device is specifically designed to stop the lift if it runs beyond the prescribed speed.

7

Rescuing System UPS with Support

This is a battery backup system that provides backup power when the regular power source fails or voltage drops to an unacceptable level. In that case, the battery mode is automatically turned on.

8



SAFETY





Customization

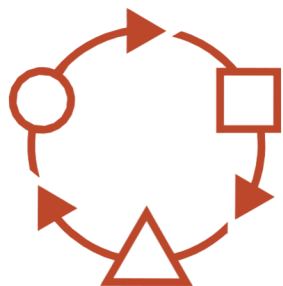

Adaptability

The technological simplicity of this product makes this lift an extremely adaptable elevator and helps you to make full usage of the space and elevation of your property. This lift can be installed without any additional reinforcement or structural changes in the building. That makes the elevator tremendously friendly for new or even vintage homes.



Flexibility

We strived to ensure full flexibility of this lift making sure that a G+1 elevator can be converted into a G+2 or a G+3 elevator in the future. If needed, the whole elevator can be completely dismantled and relocated to a new place in or out of the building or even to a new property.



Return to Home

The technology of this lift allows stationing the lift on any floor of your desire. Thanks to the installed timed electronic system, you can easily choose where your lift should land when not in use.



HOME HOME LIFT

After a solid research and development journey [HOME LIFT](#) has launched it's new [ATICO OCTAGON](#) model This elevator comes with superior aesthetics, a more sleeker design and a smoother passenger ride. This lift has been crafted to perfection until the details to assure you an [amazing lift experience!](#)

General Specifications

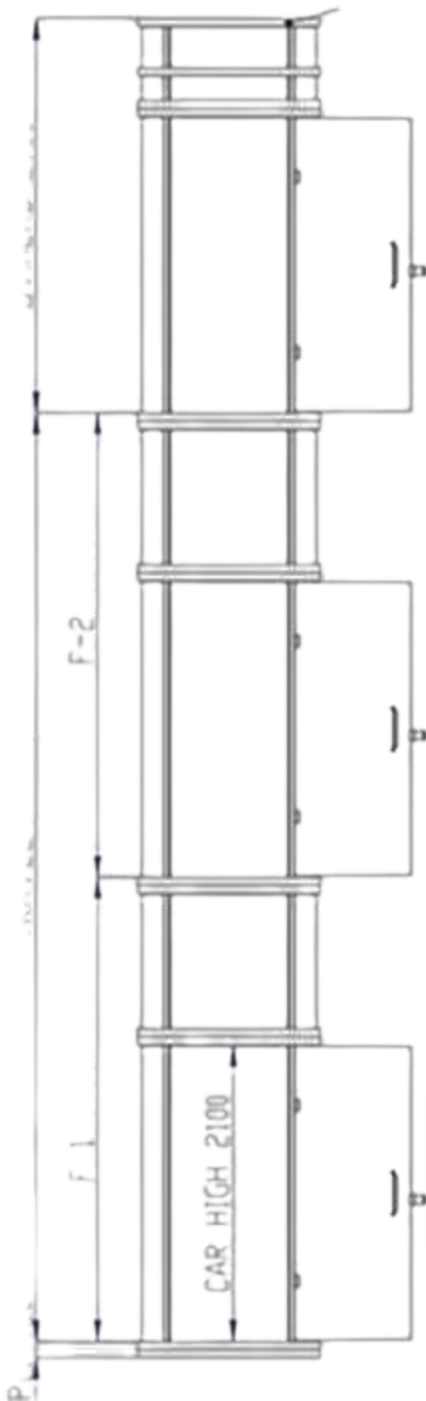

SIZE	1000 x 1000 mm	1200 x 1200 mm	1400 x 1400 mm	1600 x 1600 mm
PIT	120 MM	120 mm	120 mm	120 mm
OV. HEAD	3100 MM	3100 mm	3100 mm	3100 mm
TRAVEL (MAX)	20 MT	20 MT	20 MT	20 MT
CAPACITY	200 KG	300 KG	400 KG	500 KG
STATIC LOAD	300 KG	600 KG	700 KG	800 KG
ENCODER	FNC 50H (*EC)	FNC 50H (*EC)	FNC 50H (*EC)	FNC 50H (*EC)
SPEED		0.15 - 0.30 M/S		0.15 - 0.30 M/S
POWER SUPPLY	220 V-50 Hz	220 V-50 Hz	380 V-50 Hz	380 V- 50 Hz
MACHINE KW		3,7 KW - 1 Phase		6,8 KW - 3 Phase

Single Entrance

PRODUCT CODE	OVL-SEN-1000	OVL-SEN-1200	OVL-SEN-1400	OVL-SEN-1600
CABINET SIZE	700 X 700 MM	900 X 900 MM	1100 X 1100 MM	1300 X 1300 MM
CABINET HEIGHT	2100 MM	2100 MM	2100 MM	2100 MM
OUT DOOR SIZE	570 X 2100 MM	700 X 2100 MM	850 X 2100 MM	1100 X 2100 MM

Opposite Entrance

PRODUCT CODE	-	OVL-OPPEN-1200	OVL-OPPEN-1400	OVL-OPPEN-1600
CABINET SIZE	-	900 X 900 MM	1100 X 1100 MM	1300 X 1300 MM
CABINET HEIGHT	-	2120 MM	2120 MM	2120 MM
OUT DOOR SIZE	-	700 X 2100 MM	850 X 2100 MM	1100 X 2100 MM

Three Way Entrance

PRODUCT CODE	-	OVL-THW-1200	OVL-THW-1400	OVL-THW-1600
CABINET SIZE	-	900 X 900 MM	1100 X 1100 MM	1300 X 1300 MM
CABINET HEIGHT	-	2100 MM	2100 MM	2100 MM
OUT DOOR SIZE	-	700 X 2100 MM	850 X 2100 MM	1100 X 2100 MM

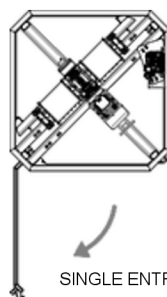
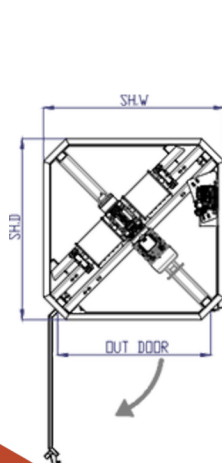
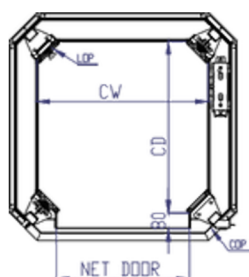

SINGLE ENTRANCE

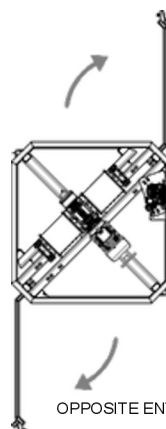

OPPOSITE ENTRANCE

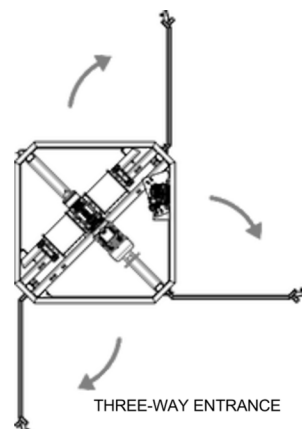

THREE-WAY ENTRANCE

Color Options

At Home lift . we offer a widerange of color variants to help you hoosing the most 'look & feel' thatsuitsyour building's décor.

Standard Options

Our ESP painting method reflects itself in a shiny surface, flexible & durable coating which is less liable to chip or peel. Al used materials are appropriate for inside or outside use with no VOC content.

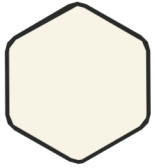

Ral 9001
Cream



Ral 1004
Golden Yellow



Ral 5002
Ultramarine Blue



Ral 9004
SignalBlack

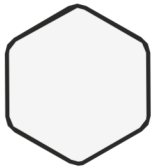

Ral 9003
Signal White



Ral 8012
Red Brown



Ral 9007
Grey Aluminium



Ral 8003
ClayBrown



You Can Choose More!

Stainless Steel Options

Alternatively we offer stainless steel covers in variant colors and cravings.

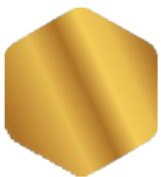

Gold Steel

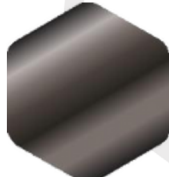

Black Steel



Stainless

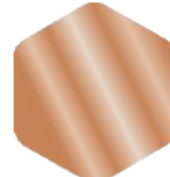

Rose Steel



Technical Specification

General

Maximum Travel	: 14 MT
Maximum Levels	: 5 Stops / 17.1 MT
Pit Depth	: 120 mm - No pit with optional short ramp
Installation Place	: Inside - Outside
Drive Train	: Winding Drum Machine with Encoder (Made in Italy)
Machine Control	: Preprogrammed variable frequency drive .
Rope	: 8 mm standard: Top quality, on request: German quality.
Transmission	: Ultra-low vibration, 3-stage, right-angle, helical-bevel drive.
Noise Level	: 54db ventilator OFF - 56db with ventilator ON.

Internal Specifications

Cabin CLADDING	: Clear Glass 4x4mm Laminated
Cabin Ceiling	: LED Spot Light - Spot Light
Cabin Operating Panel	: Intercom - Alarm - Emergency Stop Button (cop-lop is GENEMEK brand ,
Overload Indication	: Built in on COP
Cabin Flooring	: Pvc - Wood
Cop	: Intercom - alarm - fan - emergency stop button (COP-LOP).
Cabinet Ceiling	: Etched steel or wood with spot light.

External Specifications

ShaftConstruction	: Profil
Structure Cladding Glass	: Clear Glass 4x4mm Laminated
Landing Door Height	: 2100 mm
Door Cladding	: Clear Glass 4x4mm Laminated
Door Type	: Swing manuel door and swing semi-automatic choice
Door interlocks	: Italian brand - (Made in Italy)

Multiple Door Access

The door access for this elevator can be customized according to the situation in the building.

The flexible design of this elevator allows us to install the entrance or the exits from different sides on each floor.

This adjustability can be very handy within buildings that have been originally built without elevators.

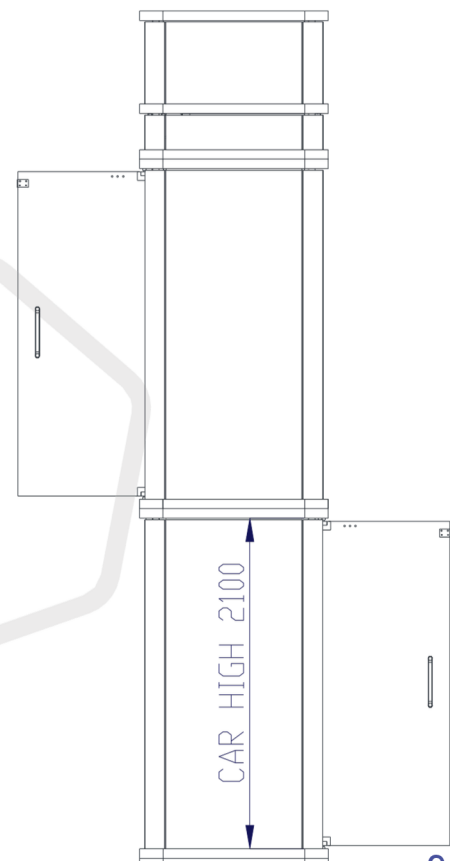



ATECO CORPORATION

اتيكو كورپريشن

www.ateco.co



**WE
RISE
TOGETHER**



**38 El-Thawra St, Almazah, Heliopolis - Cairo
Building 696 El-Horreya Road - Loran - Alexandria.**



+201020039264 - +201020039266 - +202 22903783



info@ateco.co